



禾川科技官方网站

07060201-0764-001
Date 2024-12-27
CN 安装说明
EN Installation Sheet

1. 安全注意事项 (Safety precautions)

本说明书涉及产品为工业产品，并且均为开放型外壳设计。要求用户使用产品时，务必将产品安装于具有防尘、防潮以及免于电击 / 冲击等意外的控制柜内，并且需要设置保护措施以防止非维护人员不当操作或意外导致设备故障或损坏，造成不可避免的人员危险和财产损失。

The products in this manual are industrial products and are all open-type housing designs. It is essential to install these products within a control cabinet that is safeguarded against dust, moisture, and accidents such as electric shocks or physical impacts. Additionally, protective measures must be taken to prevent malfunctions or damage caused by improper operation or accidents involving non-maintenance personnel. Failure to do so may lead to serious risks to personnel safety and potential loss of property.

更详细的信息请参考 QP 系列硬件手册。

Please refer to the QP series hardware manual for more detailed information.



QP 系列弹片式电池型号为 CR2032 (3.2V, 10mA)，可自行选购符合 UL 认证且规格参数合适的电池进行更换。

For the spring-contact battery, its model number is CR2032 (3.2V, 10mA), and it can be replaced by purchasing UL-certified batteries with appropriate specifications.

Pour la pile à contact à ressort, son numéro de modèle est CR2032 (3,2V, 10mA), et elle peut être remplacée en achetant une pile certifiée UL avec les spécifications appropriées.

2. 命名规则 (Model identification)

HC Q3 P - 1 4 0 0 - D 4 - XXXX

1	产品名称 (Product name)
HC	禾川 (Hechuan Technology)
2	产品系列 (Product series)
Q3	高端总线型运动控制器 (High-end Bus-based motion controller)
3	系列型号 (Series type)
空 (N/A)	标准型 (Standard type)
P	增强型 (Enhanced type)

4	操作系统 (Operating system)
1	Linux
5	内部编号 (Internal number)
4	预留 (Reserved)
6	控制软件模块 (Control software module)
0	CODESYS
7	控制软件 (Control software)
0	标准软件 (Standard software)

8	电源类型 (Power supply type)
D	直流电源 (DC power supply)
9	迭代版本 (Iteration version)
4	第4代 (The 4th generation)
10	软件/固件定制代码 (Customized software/firmware code)
X	0~9/A~Z/空 (N/A)

3. 适用型号 (Applicable model)

名称 (Name)	型号 (Model)	适配的 IO 型号 ¹ (Applicable IO model)	简要说明 (Brief description)
CPU单元 CPU unit	HCQ3P-1400-D4	HCQX-EC01-D4 HCQX-EC02-D4 HCQX-EC03-D4 HCQX-ES06-D4 HCQX-ID16-D4 HCQX-OD16-D4 HCQX-OD16-D4-PNP HCQX-MD16-D4 HCQX-MD16-D4-PNP HCQX-ID32-D4 HCQX-OD32-D4 HCQX-OD32-D4-PNP HCQX-MD32-D4 HCQX-MD32-D4-PNP HCQX-AD04-D4 HCQX-DA04-D4 HCQX-TS04-D4 HCQX-RS02-D4 HCQX-RS02-D4-M HCQX-OC08-D4	ARM处理器、8G EMMC、运存512M、掉电保持区1M、16点输入16点输出、32轴EtherCAT总线、8轴脉冲、2路以太网口、1路EtherCAT口、RS485*2、RS232*1、CAN*1、USB-A*1、USB-C*1、SD卡*1 ARM processor, 8G EMMC, 512M RAM, 1M persistent data memory, 16-channel input and 16-channel output, 32-axis EtherCAT bus, 8-axis pulse, 2-channel Ethernet port, 1-channel EtherCAT port, RS485*2, RS232*1, CAN*1, USB-A*1, USB-C*1, SD card*1 支持协议 (Supported protocols) : Modbus RTU, Modbus TCP, EtherCAT, CANopen, EtherNet/IP, OPC UA

*注：CPU 单元右侧可挂载模块数量以实际功率计算。

*Note: The number of modules that can be mounted on the right side of the CPU unit is calculated based on the actual power.

4. 通用电气及环境规格 (General electrical and environmental specifications)

4.1 通用电气规格 (Electrical specifications)

型号 (Model) ¹	额定电压 / 功率 (Rated voltage/power) ²	输出电压 / 功率 (Output voltage/power)	数字量输入 / 输出类型 (Digital input/output type)
HCQ3P-1400-D4	DC24V (DC 20.4V~28.8V)/22W	DC12V/16W	数字量输入 (Digital input) : DC24V, 6.81mA/Ch 芯片输出 (Digital output) : DC24V, 500mA/Ch, 4A/16Ch*3 负载类型: 阻性/电磁负载 (Resistive/Pilot duty)

*注：1. 所有型号仅能在由有限功率电源 (LPS) 提供的安全特低电压 (SELV) 下运行。

2. 此处标识的额定功率为满负载运行时的最大功率。

3. 考虑温升影响，降额使用。

*Note: 1. All models can only operate under the safety extra low voltage (SELV) provided by a limited power source (LPS).

2. The power rating indicated here is the maximum power under full-load operation.

3. Consider the effect of temperature rise and derate during using.

4.2 环境规格 (Environmental requirements)

项目	Item	规格	Specifications
海拔高度	Altitude	≤2000m	≤2000m
使用环境	Operating environment	控制柜内安装，开放式及室内使用	Installation within a control cabinet, open-type and indoor use
工作温度	Operating temperature	-10~55°C	-10~55°C
储存温度	Storage temperature	-40~75°C	-40~75°C
环境湿度	Ambient humidity	10~95%RH (无结露)	10~95%RH (non-condensing)
振动耐受	Vibration resistance	5~150Hz (X/Y/Z方向, 1g/3.5mm位移)	5~150Hz (X/Y/Z direction, 1g /3.5mm displacement)
污染等级	Pollution degree	污染度2	Level 2
冷却方式	Cooling method	自然冷却	Natural cooling
防护等级	IP rating	IP20	IP20
外壳材质	Enclosure material	阻燃材料	Self-extinguishable

*注：若设备未依制造商指定方式使用，设备所提供的保护可能会被减弱。

*Note: If the equipment is used in a manner not specified by the manufacturer, the protection provided by the equipment may be impaired.

5. 安装说明 (Installation instructions)

5.1 控制柜安装 (Installation within a control cabinet)

CN 设备冷却方式为通过加装风扇进行冷却，请保证安装方向与柜壁垂直；请参考右侧示意图，在设备的周围留有足够的空间。并排安装时，建议横向两侧预留20mm以上间距。

EN Please install the product perpendicular to the wall and ensure a sufficient cooling effect via a fan. Please leave enough clearance around the product as shown in the right figure. During a side-by-side installation, please leave a horizontal clearance of more than 20 mm on both sides.

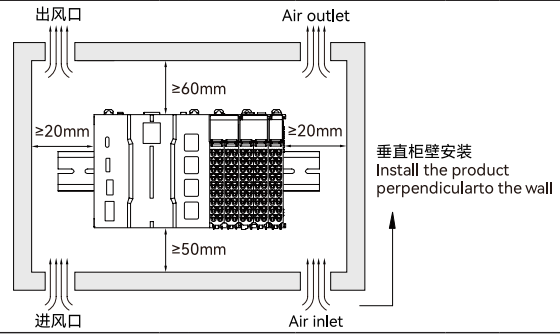

5.2 导轨拆装 (DIN rail mounting and dismounting)

CN 安装控制器时，将控制器后方双向联动卡扣上部紧扣在 DIN 导轨上，并用力按压控制器下部，听到“咔哒”声，控制器即成功安装于 DIN 导轨上（安装前应保证双向联动卡扣处于紧锁状态，否则可能导致安装故障）；拆卸控制器时（如有电源模块需先拆卸电源模块），将双向联动卡扣向上拉动一定距离，听到“咔哒”声后，取下控制器即可。

EN Before installation, check that the DIN rail mounting latch is in a locked state. During mounting, position the upper part of the mounting latch of the controller on the DIN rail, and then press the controller against the DIN rail until a clear click is heard (which indicates the latch is momentarily opened and locked onto the rail). During dismounting (if there is a power module, please dismount it first), pull the latch upwards until a clear click is heard (which indicates the latch is unlocked), and then directly remove the controller.

将双向联动卡扣上部紧扣在DIN导轨上，并向导轨侧按压控制器

Position the upper part of the mounting latch on the DIN rail, and then press the controller towards the DIN rail

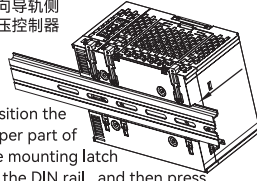

①向上拉动双向联动卡扣

Pull up to unlock the DIN rail mounting latch

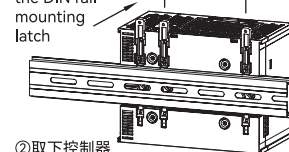

②取下控制器
Detach the controller

紧锁状态 (Locked) 释放状态 (Unlocked)

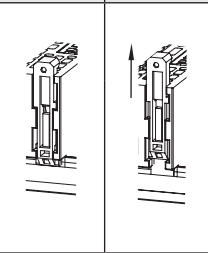

5.3 弹片接触式电池拆装 (Spring-contact battery mounting and dismounting) *

CN 弹片接触式电池组件支持电池独立更换。捏紧弹片接触式电池槽两侧后向外拔出电池组件。在电池正反两面施力，使其顺时针旋转，然后沿箭头方向取出电池，即可完成电池拆卸。将电池斜放入电池槽中，在电池正反两面施力，使其逆时针旋转至电池卡入电池槽，然后将电池组件插入控制器中，即可完成电池安装。

EN Spring-contact battery assembly supports independent battery replacement. During dismounting, pinch the spring-contact type battery compartment on both sides and then pull it outwards. Apply force to the front and back of the battery to rotate it clockwise, and then remove the battery along the direction of the arrow. During mounting, place the battery diagonally into the battery compartment, apply force on the front and back of the battery to rotate it counterclockwise until the battery clips into the battery compartment, then insert the battery compartment into the controller.

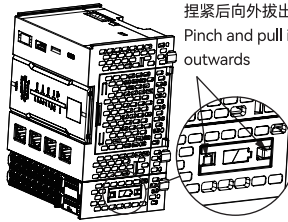

捏紧后向外拔出
Pinch and pull it outwards

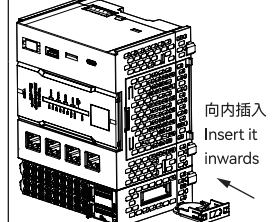
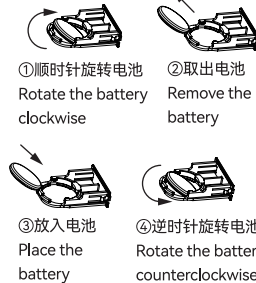

向内插入
Insert it inwards

5.4 可拆卸端子拆装 (Removable terminal block mounting and dismounting)

CN 安装可拆卸端子排时，将端子排底部对准模块底部凹槽并紧扣，上部对齐模块并向内施压，当听到“咔哒”声即完成组装；拆卸端子排时，向下按压端子排顶部卡扣，使其脱离模块本体并以底部卡扣呈圆弧形斜向下施力，将端子排取下。

EN During mounting, align the mounting hook at the bottom of the terminal block to the guide of the module and press inwards on the terminal block until a clear click is heard (which indicates the terminal block has been locked to the module). During dismounting, press the lock lever on the terminal block and then detach it from the module.

①对准卡槽
Align the hook with the guide

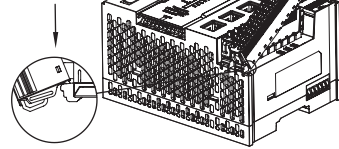

②向内按压
Press inwards

①按压端子顶部弹簧片
Press the lock lever

②取下端子
Detach the terminal block

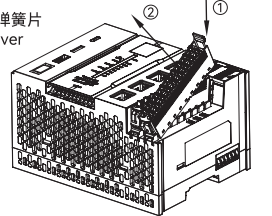

5.5 线缆拆装 1 (Cable connecting and disconnecting I)

CN 安装线缆时，将赠送的一字螺丝刀垂直插入 DC24V 电源端子压块内，施加超过 12N 的力，此时圆孔打开，将准备好的线缆插入到圆孔中，拔出一字螺丝刀，轻拽线缆，线缆不松动即成功完成配线；反之即可取出线缆。端子规格及配线示意图如右图所示。

EN During connecting, insert the flat-blade screwdriver into the DC24V power supply terminal unlocking tab with a force of more than 12 N. Then insert a cable into the circular hole. Gently tug the cable after pulling out the screwdriver. If the cable is secured firmly, then the connection is finished. The reverse is the procedure for unplugging the cable. The terminal specifications and wiring diagram are shown in the right figure.

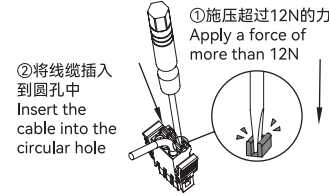

①施压超过12N的力
Apply a force of more than 12N

②将线缆插入到圆孔中
Insert the cable into the circular hole

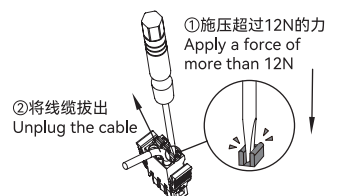

①施压超过12N的力
Apply a force of more than 12N

②将线缆拔出
Unplug the cable

控制器端子 (Terminal)	线径范围: AWG (Wire width)	剥线长度: mm (Wire stripping length)	按压力: N (Pressure)
DC24V 电源端子 (DC24V power supply terminal)	24~16	9~10	12

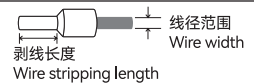

5.6 线缆拆装 2 (Cable connecting and disconnecting II)

CN 安装线缆时，将一字螺丝刀垂直插入 18Pin IO 端子压块内，施加超过 30N 的力，此时圆孔打开，将准备好的线缆插入到圆孔中，拔出一字螺丝刀，轻拽线缆，线缆不松动即成功完成配线；反之即可取出线缆。端子规格及配线示意图如右图所示。

EN During connecting, insert the flat-blade screwdriver into the 18Pin IO terminal unlocking tab with a force of more than 30N. Then insert a cable into the circular hole. Gently tug the cable after pulling out the screwdriver. If the cable is secured firmly, then the connection is finished. The reverse is the procedure for unplugging the cable. The terminal specifications and wiring diagram are shown in the right figure.

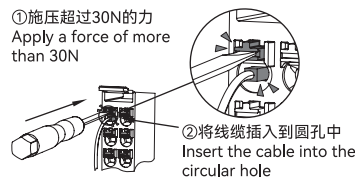

①施压超过30N的力
Apply a force of more than 30N

②将线缆插入到圆孔中
Insert the cable into the circular hole

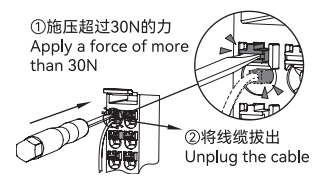

①施压超过30N的力
Apply a force of more than 30N

②将线缆拔出
Unplug the cable

控制器端子 (Terminal)	线径范围: AWG (Wire width)	剥线长度: mm (Wire stripping length)	按压力: N (Pressure)
18Pin IO端子 (18Pin IO terminal)	24~17	8~10	30

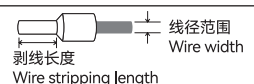

5.7 线缆拆装 3 (Cable connecting and disconnecting III)

安装线缆时，将一字螺丝刀垂直插入 12Pin 通讯端子压块内，施加超过 16N 的力，此时圆孔打开，将准备好的线缆插入到圆孔中，拔出一字螺丝刀，轻拽线缆，线缆不松动即成功完成配线；反之即可取出线缆。

CN
EN
During connecting, insert the flat-blade screwdriver into the 12Pin communication terminals unlocking tab with a force of more than 16N. Then insert a cable into the circular hole. Gently tug the cable after pulling out the screwdriver. If the cable is secured firmly, then the connection is finished. The reverse is the procedure for unplugging the cable. The terminal specifications and wiring diagram are shown in the right figure.

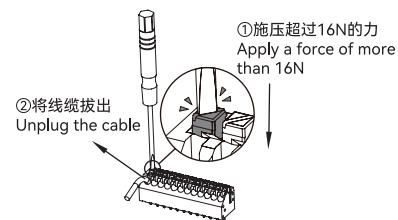
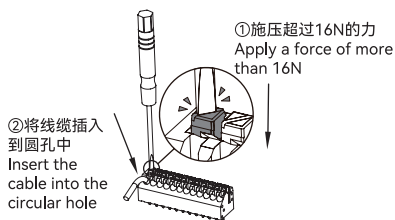

控制器端子 (Terminal)	线径范围: AWG (Wire width)	剥线长度: mm (Wire stripping length)	按压力: N (Pressure)
12Pin通讯端子 (12Pin communication terminal)	28~16	8~9	16

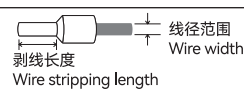

警告: 只能使用 75°C 铜导线。

Warning: Use only a copper conductor that is 75° C.

Attention: Utilisez uniquement un conducteur en cuivre à 75° C.

6. 接口和尺寸说明 (Interface and dimension description)

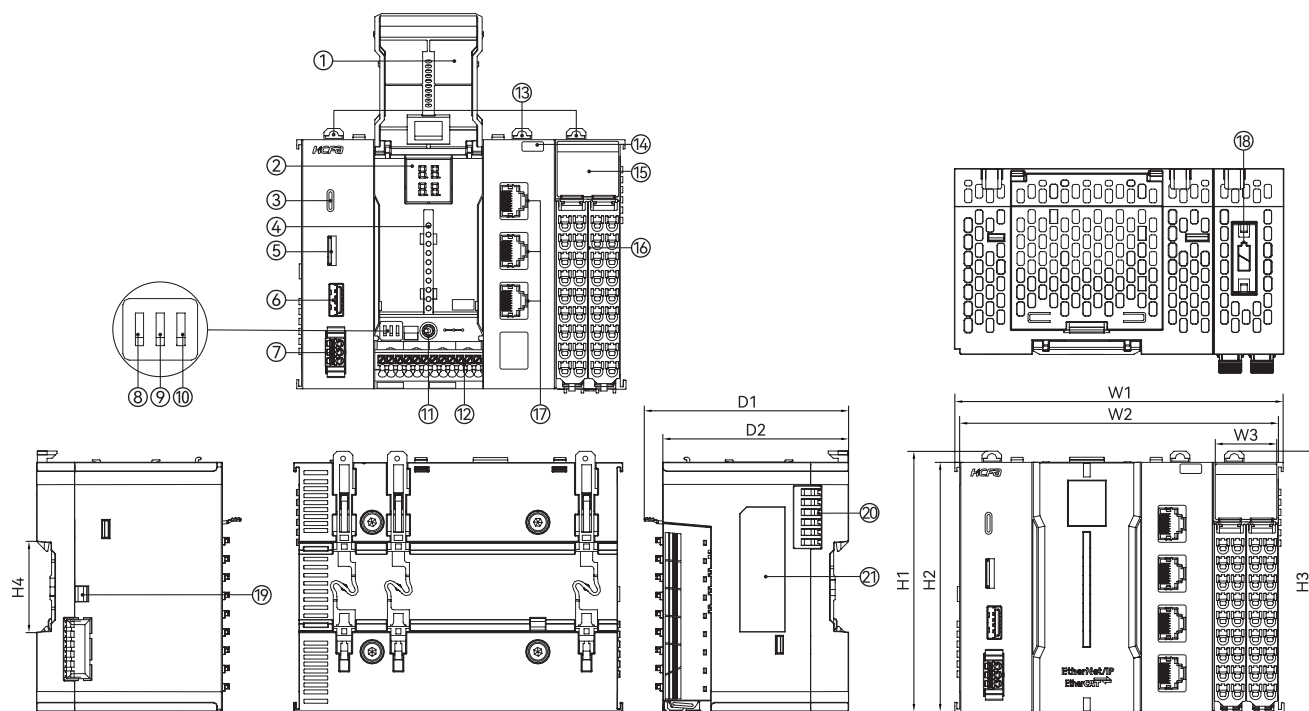

序号 (No.)	名称	Name	功能	Function
1	前翻盖	Front flip cover	保护内部指示灯与端子	Protects the indicators and terminals
2	数码管	LED	显示系统运行状态和报错代码	Displays system operation status and error code
3	Type-C接口	Type-C interface	预留接口, 支持DC5V/1A供电	Reserved interface, supports DC5V/1A power supply
4	指示灯	Indicator	显示控制器运行, SD卡/U盘连接与通讯接口状态	Displays the status of controller operation, SD card/U disk connection, and communication interface
5	SD卡槽	SD card slot	支持Micro SD卡插入, 用于数据存储, 程序导入导出	Supports Micro SD card insertion for data storage, program import, and export
6	USB-A接口	USB-A interface	支持U盘导入/导出程序与文件读写, 支持DC5V/1A供电	Supports U disk program import/export and file reading/writing, supports DC5V/1A power supply
7	DC24V电源端子	DC24V power supply terminal	DC24V供电接口	DC24V power supply interface
8	COM1终端电阻开关	COM1 termination resistor switch	向上拨动为开启终端电阻, 向下拨动为关闭终端电阻, 出厂默认关闭状态	Toggle up to turn on the terminating resistor, toggle down to turn off the terminating resistor, off by factory default
9	COM2终端电阻开关	COM2 termination resistor switch		
10	CAN终端电阻开关	CAN termination resistor switch		
11	STOP/RUN/FN 拨码开关	STOP/RUN/FN dial switch	功能拨码, 向左为控制器停止状态, 中间为运行状态, 向右拨至FN并停留3s为恢复Port1/port2 IP默认值	DIP switch. Toggle to the left to put the controller in the STOP state. Toggle to the center to put it in the RUN state. Toggle to the right to put it to the FN state for 3s to restore the IP addresses of Port1/port2 to the default value
12	12Pin通讯端子	12Pin communication terminal	RS485/RS232/CAN通讯接口	RS485/232/CAN communication interface
13	双向联动卡扣	DIN rail mounting latch	固定模块在DIN导轨上	Mounts the module onto a DIN rail
14	产品型号	Product model	显示CPU单元型号	Displays CPU unit model
15	模块状态指示灯	Module status indicator	显示模块与通道状态	Displays module and channel status
16	18Pin IO端子	18Pin IO terminal	左侧输入 16通道数字量输入 右侧输出 16通道数字量输出	16-channel digital input 16-channel digital output
17	RJ45 通讯接口	RJ45 communication interface	Port1 EtherNet 千兆以太网口, 支持Modbus TCP、OPC UA、EtherNet/IP Scanner和Adapter Port1 IP: 192.168.188.100 Port2 EtherNet 千兆以太网口, 支持Modbus TCP、OPC UA、EtherNet/IP Scanner和Adapter Port2 IP: 192.168.88.100 Port3 EtherCAT 百兆以太网口, 支持EtherCAT主站	Gigabit Ethernet port, supports Modbus TCP, OPC UA, EtherNet/IP Scanner and Adapter Port1 IP: 192.168.188.100 Gigabit Ethernet port, supports Modbus TCP, OPC UA, EtherNet/IP Scanner and Adapter Port2 IP: 192.168.88.100 Fast Ethernet port, supports EtherCAT master
18	RTC电池	RTC battery	维持部分系统参数	Maintains part of the system parameters
19	金属弹片 (悬空)	Metal spring (float)	无功能, 预留接口	No function, reserved interface
20	扩展模块通讯接口	Expansion terminal communication interface	主机和IO模块通讯及供电接口, 不支持热插拔	The interface for the communication and power supply of the host and IO modules, does not support hot-swapping
21	标签	Label	显示CPU单元型号, 规格参数、内部序列号等基本信息	Displays the basic information including CPU unit model, specification parameters, and internal serial number

型号 (Model)	外形尺寸 (Dimension) : mm									重量 (Weight) : g
	W1	W2	W3	H1	H2	H3	H4	D1	D2	
HCQ3P-1400-D4	132.2	127.9	24.4	104.5	100.0	105.5	35.4	82.0	74.5	816 approx.

7. 指示灯说明 (Indicator description)

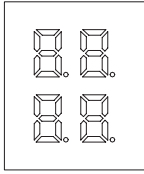

数码管 (LED)	状态	Status	说明	Description
H L F R	开机	Boot	开机中	Booting up
F L L R	Run	Run	正常运行	Run
F L L R	Stop	Stop	停止	Stop
E R R	报错	Error	错误代码	Error code

丝印 (Screen printing)	指示灯含义 (Indicator meaning)	颜色 (Color)	状态	Status	说明	Description
SYS	系统状态 (System status)	红色 Red	其他 Other	Other	发生故障	Error
			闪烁 Blinking	Blinking	正常运行	Run
SD_BUSY	SD 卡 / U 盘 (SD card / U disk)	红色 Red	熄灭 Not lit	Not lit	SD 卡 / U 盘安全卸载或全部拔出	Uninstall or unplug the SD card / USB flash drive successfully
			常亮 Lit	Lit	成功加载 SD 卡 / U 盘	Load the SD card / USB flash drive successfully
CAN *	CANOpen 通讯 (CANOpen communication)	-	-	-	-	-
COM1	RS485 通讯 (RS485 communication)	TX 绿色 Green	熄灭 Not lit	Not lit	未发送数据	No data is being sent to other devices
COM2			闪烁 Blinking	Blinking	正在发送数据给其他设备	Data is being sent to other devices
COM3	RS232 通讯 (RS232 communication)	RX 红色 Red	熄灭 Not lit	Not lit	未接收数据	No data is being received from other devices
			闪烁 Blinking	Blinking	正在接收其他设备发送的数据	Data is being received from other devices
QBUS L/A	QBUS 通讯 (QBUS communication)	黄色 Yellow	熄灭 Not lit	Not lit	通讯断开 / 故障	Communication is abnormal or disconnected
			闪烁 Blinking	Blinking	通讯正常	Communication is normal
IN N (0~7,10~17)	输入 (Input)	绿色 Green	熄灭 Not lit	Not lit	输入通道 N 未检测到输入信号	The input channel N has not detected input signals
			常亮 Lit	Lit	输入通道 N 检测到输入信号	The input channel N has detected input signals
OUT N (0~7,10~17)	输出 (Output)	绿色 Green	熄灭 Not lit	Not lit	输出通道 N 无信号输出	There is no output signal in this channel
			常亮 Lit	Lit	输出通道 N 有信号输出	There are output signals in this channel
EtherNet EtherCAT	LINK 物理连接 (Physical connection)	绿色 Green	熄灭 Not lit	Not lit	未建立物理连接	Physical connection has not been established
			常亮 Lit	Lit	已建立物理连接	Physical connection has been established
	ACT 数据交互 (Data exchange)	黄色 Yellow	熄灭 Not lit	Not lit	未收发数据	No data is being sent or received
			闪烁 Blinking	Blinking	正在收发数据	Data is being sent or received

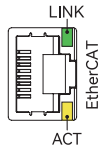
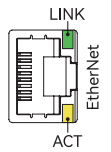
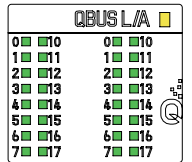
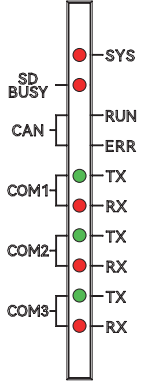

*注: 后续支持。
*Note: It will be supported subsequently.

8. 端子及配线说明 (Terminal and wiring description)

DC24V 电源端子说明 (DC24V power supply terminal description)		接线 (Wiring)
24V		
0V		
⏚		

18Pin IO 端子说明 (18Pin IO terminal description)		IN		OUT		类型 (Type)	通用IO接线 (General IO wiring)	高速IO接线 (High-speed IO wiring)
0		10	I0	I10	Q0	Q10	开关 Switch 漏型输入 NPN Input	编码器 Encoder 屏蔽层 Shield 0V DC24V
1		11	I1	I11	Q1	Q11		
2		12	I2	I12	Q2	Q12		
3		13	I3	I13	Q3	Q13	开关 Switch 源型输入 PNP Input	编码器 Encoder 屏蔽层 Shield 0V DC24V
4		14	I4	I14	Q4	Q14		
5		15	I5	I15	Q5	Q15		
6		16	I6	I16	Q6	Q16	负载 Load 漏型输出 NPN Output	脉冲PLS_out 方向PLS_dir DC24V
7		17	I7	I17	Q7	Q17		
8	18	SS*	SS*	COM*	COM*			

*注：输入公共端 SS 内部导通，输出公共端 COM 内部导通。

*Note: The input terminals SS are internally conductive, and so are the output terminals COM.

12Pin通讯端子说明 (12Pin communication terminal description)

定义 (Definition)	A1	B1	SG	A2	B2	SG	TX	RX	SG	H	L	SG
接口 (Interface)	COM1			COM2			COM3			CAN		

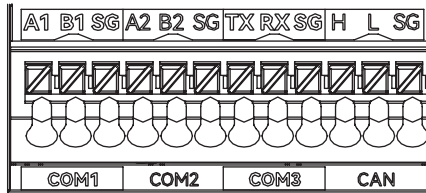

COM1/COM2 RS485接线 (RS485 Wiring)

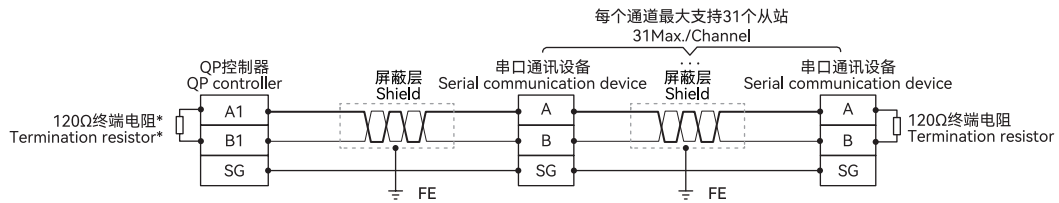

COM3 RS232接线 (RS232 Wiring)

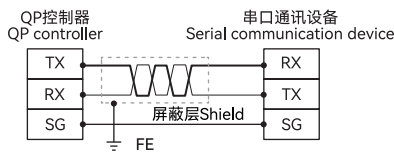

CAN CANOpen接线 (CANOpen Wiring)

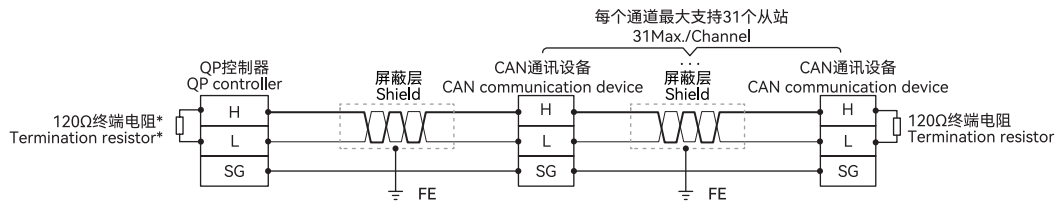

*注：内置终端电阻，通过终端电阻拨码开关启用。

*Note: Built-in terminating resistor, which is enabled by the terminating resistor DIP switch.